

InfiniiMax III/III+ Probing System

The World's Highest Performing Probe System
Keeps Getting Better

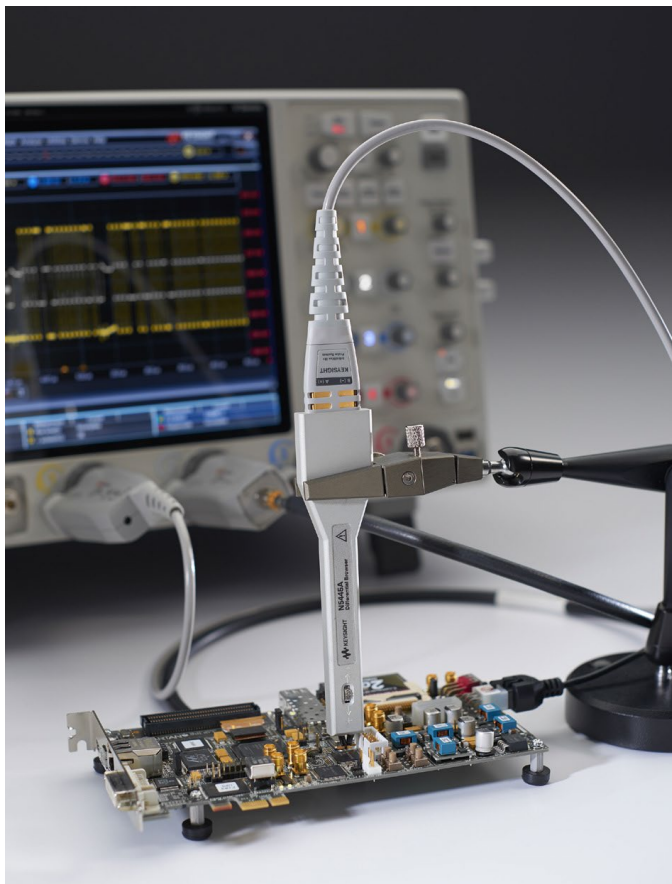

Unmatched Performance

- Full 30 GHz bandwidth to the probe tip
- InfiniiMode probing for making differential, single-ended and common mode measurements with a single probe (with InfiniiMax III+)
- Industry's highest fidelity and accuracy due to bandwidth and extremely low loading
- Probe amplifiers loaded with measured s-parameters for more accurate response correction
- Bandwidth upgradable (InfiniiMax III only)
- Variety of probe heads for different use models with maximum usability

Industry-leading probe performance

The InfiniiMax III probing system offers you the highest performance available for measuring differential and single-ended signals, with flexible connectivity solutions for today's high-density ICs and circuit boards. Four different InfiniiMax III probe amplifiers ranging from 16 to 30 GHz are available for matching your probing solution to your performance and budget requirements. A proprietary 200 GHz ft InP (indium phosphide) IC process with backside ground vias and novel thick film technology is utilized to accommodate your highest performance needs and is unmatched by any product in the market.

The N2830A/N7000A Series InfiniiMax III+ probing system is the next generation of InfiniiMax probing, greatly expanding the measurement capabilities and usability of a probe capable of measuring all components of a differential signal. The built-in InfiniiMode technology allows you to switch to differential, single-ended, and common mode without adjusting probe tip connections. The InfiniiMax III+ probe's InfiniiMode provides the following modes of operation.

- A - B (differential)
- A - ground (single-ended A)
- B - ground (single-ended B)
- (A+B)/2 - ground (common mode)

The InfiniiMax III+ works with the full array of InfiniiMax III probe heads and supports the full bandwidth of the InfiniiMax III+.



InfiniiMax III probe amplifier



InfiniiMax III+ probe amplifier (N2830A Series)



InfiniiMax III+ probe amplifier (N7000A Series)

Highest fidelity and accuracy

The InfiniiMax III provides the highest bandwidth and incredibly low loading to allow for a new level of signal fidelity and accuracy. Continuing the probe head topology pioneered by Keysight Technologies, Inc. in the InfiniiMax I and II probe systems, five probe heads are provided to accommodate multiple use models: a 30 GHz browser that is extremely usable, a 25/28 GHz ZIF probe head with economical replaceable/removable ZIF tips, a 30 GHz 2.92 mm probe head which allows cabled measurements using 2.92 mm, 3.5 mm, or SMA coax cables, an economical 26 GHz solder-in probe head for demanding measurements, and a 16 GHz QuickTip for a quick and secure connection.



More accurate probe correction

Each individual InfiniiMax III and III+ probe amp contains its unique S-parameters, and this frequency response data is used with the S-parameters of the various probe heads to further flatten the probe's magnitude and phase response for accuracy. Traditionally, probe correction uses a nominal model based on a typical probe amplifier instead of the specific amplifier. Generally, the biggest variation between probing systems is a result of the probe amplifier. The ability to correct a specific probe amplifier's response results in a more accurate probe correction, which yields a more accurate measurement.

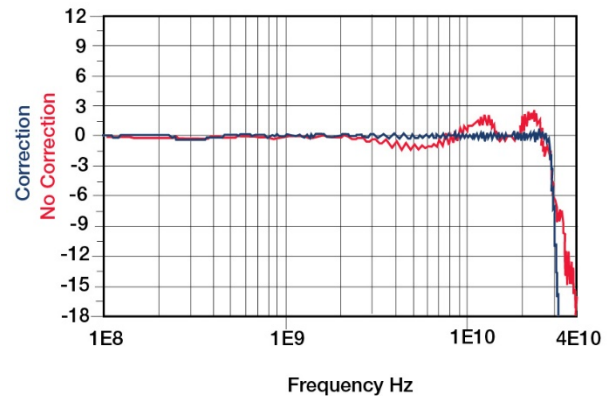

Uncompromised Usability

Extensive line-up of probe heads and accessories

Keysight's InfiniiMax III/III+ probes support a wide variety of high-speed applications with an extensive line-up of probe heads and accessories.

The N5445A browser head (30 GHz) is the best choice for quick general-purpose troubleshooting of differential signals with its z-axis compliance and variable spacing from 20 mil to 125 mil (or 0.5 mm to 3.1 mm). The span between the signal tips is easily adjusted with a thumb wheel on the browser. Integrated LED lighting at the tip illuminates the probing area for better visibility. Order N5476A for replacement browser tips (set of 4).

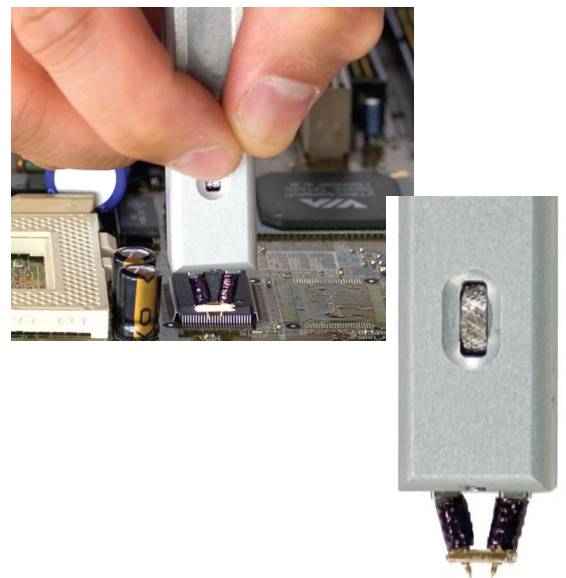

The N2848A/49A QuickTip offers the industry's first magnetically-engaged probe head and tip for a quick and secure connection, pushing the usability to the next level. The N2848A QuickTip probe head quickly snaps to the N2849A probe tip, utilizing magnets to connect to the two sides of the differential signal and ground. Multiple N2849A probe tips can be installed on a DUT, allowing quick and reliable measurement of many probe points. The QuickTip supports the InfiniiMode probing when used with the InfiniiMax III+ probe amp and supports differential probing with the InfiniiMax III probe amp. The N2849A QuickTip tips can also be used with the InfiniiMax I/II probe amps when used in conjunction with the N2851A QuickTip probe head for InfiniiMax I/II.

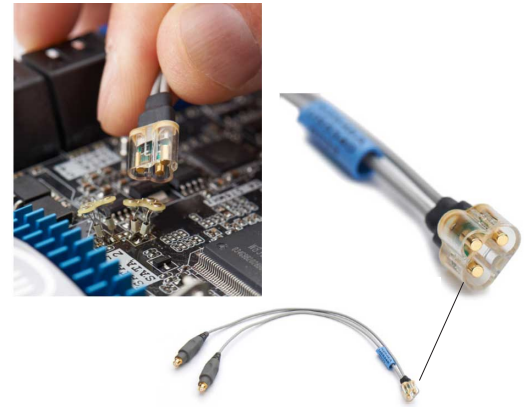

The N5439A ZIF probe head provides 28 GHz bandwidth in an economical replaceable tip form factor. For differential measurement, the N5439A ZIF probe head with the N5440A or N5447A ceramic ZIF tip provides the industry's lowest signal loading. The ZIF tips can be left on the DUT as the probe head is moved from one probing site to the next. Order N5440A (450 Ω ceramic), N5447A (200 Ω ceramic) or the new N2838A (450 Ω PC board) for a set of 5 ZIF tips with plastic sporks to aid in soldering the tips to your DUT. The N2838A PC board ZIF tip increased the robustness of the ZIF tip significantly while maintaining the bandwidth performance up to 25 GHz when used in conjunction with the N2803A and N5439A. Variable spacing from 5 mil to 80 mil (or 0.127 mm to 2 mm). (The N5447A 200 Ω ZIF tip is not compatible with InfiniiMax III+ probes.)



The N5444A 2.92 mm/3.5 mm/SMA probe head (30 GHz) allows you to connect two 2.92 mm, 3.5 mm or SMA cables to make a differential measurement on a single oscilloscope channel. Order N5448B 2.92 mm head flex cables (10" or 25 cm) or N2823A 2.92 mm cables with 1 m to extend the cable length and add convenience. You can control the termination voltage of the N5444A probe head using either the Infiniiium scope software or by using a N5444-61601 cable included in the N5444A kit connected to your own DC power supply.

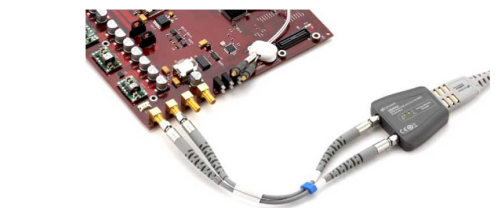

For extended temperature testing with extreme temperature range measurements, the MX0109A 26 GHz solder-in head supports extreme operating temperature of -55 to +150 °C per JEDEC JESD22-A104 revision E. Variable span of leads ranges from 5 to 250 mil. Damping resistor tips are user replaceable when damaged. This probe head is form, fit, function compatible with N2836A. This probe head supports InfiniiMode probing when used with the InfiniiMax III+ probe amp.



The N2836A solder-in head provides up to 26 GHz bandwidth when used in conjunction with the N2803A probe amplifier. This probe head supports InfiniiMode probing when used with the InfiniiMax III+ probe amp.

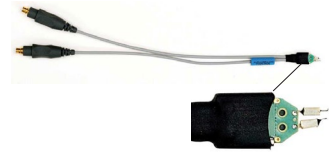

The N5442A Precision BNC 50 Ω adapter allows you to use your existing InfiniiMax I (1130B-1134B), InfiniiMax II (1168B/69B), N2750A-52A, N2795A-97A active probes or a general purpose 50 Ω BNC cable with the V, 90000 X- or 90000 Q-Series oscilloscope.



The N5449A high impedance adapter allows connection for probes that require a high impedance scope input such as a high impedance passive probe, 1147B/N2893A current probe, or N2790A differential probe to the Infiniium V, 90000-X/Q Series oscilloscopes. The N5449A provides switchable AC/DC coupling as well as 10:1 and 1:1 attenuation settings. The adapter comes with a N2873A 500 MHz 10:1 passive probe.



The N5477A sampling oscilloscope adapter makes the InfiniiMax III probing system fully compatible with the Infiniium 86100C DCA-J sampling oscilloscope. Previously the DCA-J was limited to 13 GHz of probing, but with the N5477A, the DCA-J now has 30 GHz of probing, increasing its performance and flexibility. To use the InfiniiMax III+ probe on sampling oscilloscopes, order the N1022B probe adapter and the 1143A probe offset control and power module.



The MX0104A performance verification and deskew fixture is required to calibrate and verify the performance of the InfiniiMax III probe. The MX0104A is a replacement of the N5443A. The MX0104A comes with the 50 ohm through fixture only. You have an option to choose the option 001 plastic stand or the option N2787A 3D probe positioner which will help you properly position the probe amplifier. Order E2655C to calibrate and verify the performance of the InfiniiMax probe with < 13 GHz of bandwidth.



Bandwidth upgradability (for InfiniiMax III)

As frequencies have continued to increase, so have the cost of probes. The InfiniiMax III system offers the world's first fully upgradable probe amplifier. Purchase a 16 GHz probe amplifier today, knowing that in the future, you can upgrade the amplifier to higher bandwidths (20/25/30 GHz) at a fraction of the cost of a new probe amplifier.

InfiniiMax III/III+ Probing System Family Diagram

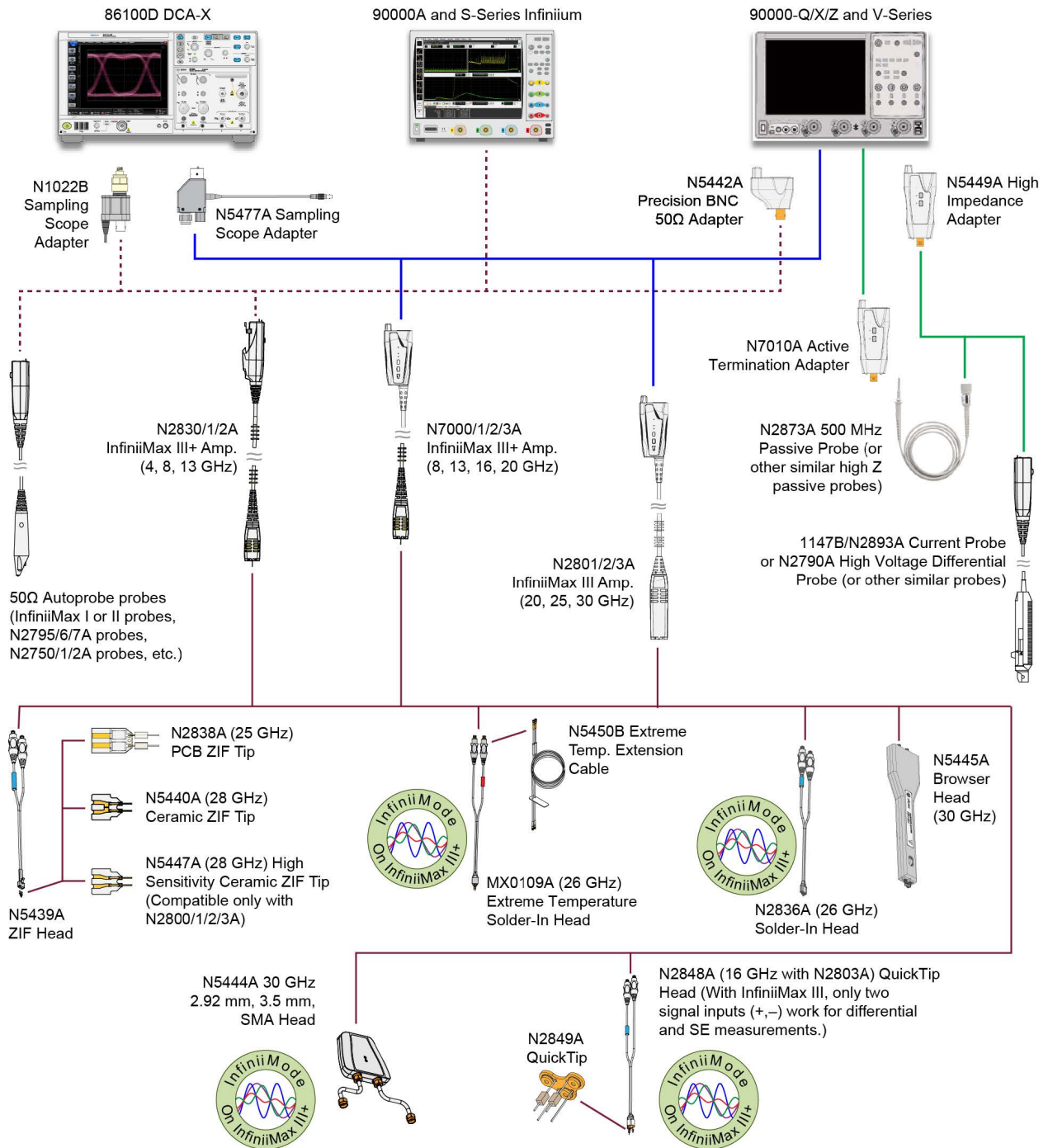

Performance Specifications and Characteristics

InfiniiMax III/III+ warranted specifications

| Probe head | Probe amp | Bandwidth | DC input |
|---|---|-----------|-----------------------------------|
| N5440A_N5439A ceramic 450 Ω ZIF tip and ZIF probe head | N2803A 30 GHz probe amp | 26 GHz | Rdiff=100 kΩ ± 2%, Rse=50 kΩ ± 2% |
| N5445A 450 Ω browser | N2803A 30 GHz probe amp | 28 GHz | Rdiff=100 kΩ ± 2%, Rse=50 kΩ ± 2% |
| MX0109A/N2836A 450 Ω solder-in probe head vertical orientation with no ground wires | Differential mode N7003A 20 GHz probe amp | 20 GHz | Rdiff=100 kΩ ± 2%, Rse=50 kΩ ± 2% |

InfiniiMax III/III+ probe head characteristics

These characteristics are mainly determined by the probe head. Performance numbers listed are: –3 dB bandwidth/10 to 90% transition time/20 to 80% transition time. Performance listed is with the highest bandwidth probe amp models in each family. Performance with lower bandwidth amps is the lower of the: AmpBW, (.434/AmpBW), (.308/AmpBW), or bandwidth measured with the highest bandwidth amp in the family.

| Probe head | Input C | InfiniiMax III N2803A | InfiniiMax III+ N7003A 20-GHz probe amp | | |
|---|-----------------------------|--------------------------|---|-------------------|-------------|
| | | 30-GHz probe amp | Differential mode | Single-ended mode | Common mode |
| N5440A_N5439A ceramic 450 Ω ZIF tip and ZIF probe head | Cdiff=32 fF; Cse=44 fF | 28 GHz, 15.5 pS, 11.0 pS | 20 GHz, 21.7 pS, 15.4 pS | N/A | |
| N5447A_N5439A ceramic 200 Ω ZIF tip and ZIF probe head | Cdiff=32 fF; Cse=44 fF | 28 GHz, 15.5 pS, 11.0 pS | N/A | | |
| N5445A 450 Ω browser | Cdiff=35 fF; Cse=50 fF | 30 GHz, 14.5 pS, 10.3 pS | 20 GHz, 21.7 pS, 15.4 pS | N/A | |
| N2838A_N5439A PC board 450 Ω ZIF tip and ZIF probe head | Cdiff=95 fF; Cse=130 fF | 25 GHz, 17.4 pS, 12.3 pS | 20 GHz, 21.7 pS, 15.4 pS | N/A | |
| MX0109A/N2836A 450 Ω solder-in probe head vertical orientation with no ground wires | Cdiff=108 fF; Cse=140 fF | 27 GHz, 16.1 pS, 11.4 pS | 20 GHz, 21.7 pS, 15.4 pS | N/A | |
| MX0109A/N2836A 450 Ω solder-in probe head flat orientation with minimum length ground wires | Cdiff=108 fF; Cse=140 fF | 27 GHz, 16.1 pS, 11.4 pS | 20 GHz, 21.7 pS, 15.4 pS | | |
| N2849A_N2848A 450 Ω QuickTip and QuickTip probe head with ground wires connected | Cdiff=340 fF; Cse=200 fF | 16 GHz, 27.1 pS, 19.3 pS | 20 GHz, 21.7 pS, 15.4 pS | | |
| N5444A 2.92 mm, SMA, 3.5 mm probe head | N/A | 30 GHz, 15.5 pS, 11.0 pS | 20 GHz, 21.7 pS, 15.4 pS | | |

InfiniiMax III/III+ probe amp characteristics

These characteristics are mainly determined by the probe amp.

| Features | N280XA InfiniiMax III probe amp | | N5444A 2.92 mm, SMA, 3.5 mm probe head | N283XA InfiniiMax III+ probe amp | |
|--|---|---|---|---|---|
| | 450 Ω probe heads | 200 Ω probe heads | | 450 Ω probe heads | N5444A 2.92 mm, SMA, 3.5 mm probe head |
| DC input resistance | Rse=50 kΩ ± 2% each input to ground, Rdiff=100 kΩ ± 2% and Rcm=25 kΩ ± 2% | Rse=50 kΩ ± 2% each input to ground, Rdiff=100 kΩ ± 2% and Rcm=25 kΩ ± 2% | 55 Ω to Vterm | Rse=50 kΩ ± 2% each input to ground, Rdiff=100 kΩ ± 2% and Rcm=25 kΩ ± 2% | 55 Ω to Vterm |
| Input resistance > 10 kHz | Rse=500 Ω each input to ground, Rdiff=1 kΩ and Rcm=250 Ω | Rse=500 Ω each input to ground, Rdiff=1 kΩ and Rcm=250 Ω | 50 Ω to .901*Vterm | Rse=500 Ω each input to ground, Rdiff=1 kΩ and Rcm=250 Ω | 50 Ω to .901*Vterm |
| Input voltage range (differential or single-ended), mains isolated | 1.6 Vpp, ± 0.8 V (HD2&3 < -38 dbc), 2.5 Vpp, ± 1.25 V (HD2&3 < -34 dbc) | 0.8 Vpp, ± 0.4 V (HD2&3 < -38 dbc), 1.6 Vpp, ± 0.8 V (HD2&3 < -34 dbc) | 1.6 Vpp, ± 0.8 V (HD2&3 < -38 dbc), 2.5 Vpp, ± 1.25 V (HD2&3 < -34 dbc) | 2.5 Vpp or ± 1.25 V at 5:1 attenuation, 5.0 Vpp or ± 2.50 V at 10:1 attenuation | 2.5 Vpp or ± 1.25 V at 5:1 attenuation, 5.0 Vpp or ± 2.50 V at 10:1 attenuation without violating max input power |
| Max input power | N/A | N/A | 125 mW calculated by $\{[rms(vin-vterm)]^2/55\}$ for each input | N/A | 125 mW calculated by $\{[rms(vin-vterm)]^2/55\}$ for each input |
| Input common mode range | ± 2 VDC to 250 Hz, ± 1.25 V > 250 Hz | ± 6 VDC to 250 Hz, ± 0.65 V > 250 Hz | ± 6 VDC to 250 Hz, ± 1.25 V > 250 Hz without violating max input power | ± 7 VDC to 100 Hz, ± 1.25 V > 100 Hz at 5:1 attenuation, ± 2.5 V > 100 Hz at 10:1 attenuation | ± 6 VDC to 100 Hz, ± 1.25 V > 100 Hz at 5:1 attenuation, ± 2.5 V > 100 Hz at 10:1 attenuation without violating max input power |
| DC attenuation ratio | 6:1 | 3:1 | 6:1 | 5:1 or 10:1 Automatically selected based on volts/division (all modes) | 5:1 or 10:1 Automatically selected based on volts/division (all modes) |
| Offset range (for probing a single-ended signal) | ± 16 V | ± 8 V | ± 6 V without violating max input power | ± 16 V | ± 6 V without violating max input power |
| Input referred noise spectral density | 23.9 nV/rt (Hz) | 12.0 nV/rt (Hz) | 23.9 nV/rt (Hz) | Diff 5:1 atten 33.5 nV/rt (Hz) | |
| | | | | Diff 10:1 atten 53.9 nV/rt (Hz) | |
| | | | | SE A or B 5:1 atten 27.8 nV/rt (Hz) | |
| | | | | SE A or B 10:1 atten 47.7 nV/rt (Hz) | |
| | | | | CM 5:1 atten 21.8 nV/rt (Hz) | |
| CM 10:1 atten 38.4 nV/rt (Hz) | | | | | |
| Input referred noise example | 4 mVrms with 28 GHz probe head and 30 GHz probe amp | 2 mVrms with 28 GHz probe head and 30 GHz probe amp | 4 mVrms | 4.5 mVrms in diff mode 5:1 atten with >= 18 GHz probe head and 13 GHz probe amp | 4.5 mVrms in diff mode 5:1 atten with 30 GHz N5444A probe head and 13 GHz probe amp |
| Maximum input voltage | 18 Vpeak mains isolated | 18 Vpeak mains isolated | 8 Vpeak without violating max input power | 18 Vpeak mains isolated | 8 Vpeak without violating max input power |

What is InfiniiMode?

InfiniiMode allows convenient measurement of differential, single-ended and common mode signals with a single probe tip - without reconnecting the probe from its connection point.

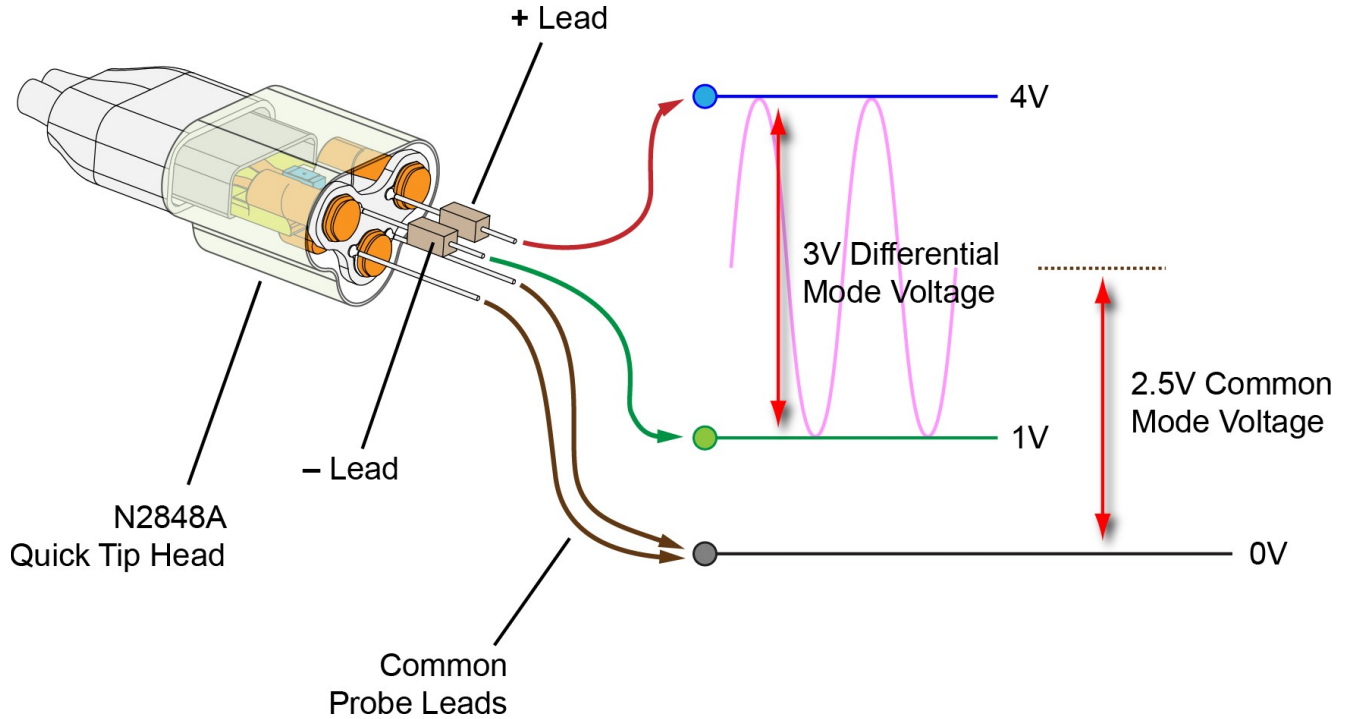

Ordering Information

InfiniiMax III/III+ probe amplifier models

| Model number | Description | Recommended oscilloscope |
|--------------|--|--|
| N2803A | 30 GHz InfiniiMax III probe amplifier | Infiniium 90000X/Q/Z Series 28 to 63 GHz models |
| N2802A | 25 GHz InfiniiMax III probe amplifier | Infiniium 90000X/Q/Z Series 25 GHz models |
| N7003A | 20 GHz InfiniiMax III+ probe amplifier | Infiniium 90000X/V/Q/Z Series 20 GHz models |
| N2801A | 20 GHz InfiniiMax III probe amplifier | Infiniium 90000X/Q/Z Series 20 GHz models |
| N7002A | 16 GHz InfiniiMax III+ probe amplifier | Infiniium 90000V/X Series 16 GHz models |
| N2800A | 16 GHz InfiniiMax III probe amplifier | Infiniium 90000X Series 16 GHz models, discontinued and replaced by N7002A |
| N7001A | 13 GHz InfiniiMax III+ probe amplifier | Infiniium 90000V/X Series 13 GHz models |
| N2832A | 13 GHz InfiniiMax III+ probe amplifier | Infiniium 90000X 13 GHz and 90000A models |
| N7000A | 8 GHz InfiniiMax III+ probe amplifier | Infiniium 90000V Series 8 GHz models |
| N2831A | 8 GHz InfiniiMax III+ probe amplifier | Infiniium 90000A and S-Series |
| N2830A | 4 GHz InfiniiMax III+ probe amplifier | Infiniium 90000A and S-Series |

Note: InfiniiMax III and III+ probe amps are not compatible with existing InfiniiMax I or II probe heads.

InfiniiMax III/III+ probe heads

| Model number | Description | Notes |
|--------------|--|--|
| N2848A | InfiniiMax III QuickTip probe head | Compatible with InfiniiMax III/III+ amp Supports InfiniiMode with InfiniiMax III+ amp |
| N2849A | InfiniiMax III QuickTip tips | Set of 4 tips |
| N5445A | InfiniiMax III browser head | Order N5476A for replacement probe tips (set of 4) |
| N5439A | InfiniiMax III ZIF probe head | Order N2838A PC board ZIF (450 Ω), N5440A Ceramic ZIF (450 Ω) or N5447A Ceramic ZIF (200 Ω) for a set of 5 ZIF tips with plastic sporks |
| N5444A | InfiniiMax III 2.92 mm/3.5 mm/SMA probe head | Order N5448B (25 cm) or N2823A (1 m) 2.92 mm (m)-to-2.92 mm (m) head flex cables to extend the cable length. Supports InfiniiMode with InfiniiMax III+ amp |
| N5441A | InfiniiMax III 16 GHz solder-in probe head | Discontinued and replaced by N2836A and MX0109A |
| N2836A | InfiniiMax III 26 GHz solder-in probe head | Supports InfiniiMode with InfiniiMax III+ amp. Order N2836-68701 for damping resistor replacement tips |
| N2835A | InfiniiMax III differential connectivity kit | Contains 1x N5445A, 2x N2836A, 2x N5439A, 2x N2838A, 2x N2848A, 2x N2849A |
| MX0109A | InfiniiMax III 26 GHz Extreme temperature solder-in probe head | Supports -55 to +150 °C of operating temperature range and InfiniiMode with InfiniiMax III+ amp. Order N2836-68701 for damping resistor replacement tips |

Note: InfiniiMax III/III+ probe heads are not compatible with InfiniiMax I or II probe amps.

InfiniiMax III probe adapters

| Model number | Description | Notes |
|--------------|---|--|
| N5442A | Precision BNC adapter (50 Ω) | For use with InfiniiMax I/II/III+ probes, N2750A-52A, N2795A/96A/97A, 1156A-58A etc. |
| N5449A | High impedance probe adapter | Includes one N2873A 500 MHz 10:1 passive probe |
| N5477A | Sampling scope adapter | For InfiniiMax III amp to use with Keysight 86100C DCA-J sampling scope |
| N1022B | Probe adapter | For InfiniiMax III+ amp to use with 86100C DCA-J sampling scope |
| MX0104A | Performance verification and deskew fixture | For InfiniiMax III and InfiniiMax III+ > 13 GHz. Order option 001 plastic stand or theoption N2787A 3D probe positioner. |
| E2655C | Performance verification and deskew fixture | For InfiniiMax III+ ≤13 GHz and InfiniiMax I/II |
| N2852A | AutoProbe II to AutoProbe III interface adapter for Infinium UXR Series | |

Probe bandwidth upgrade options (for InfiniiMax III only)

| Model number | Description | Notes |
|--------------|--------------------------------|-------|
| N5446A-001 | 16 to 20 GHz bandwidth upgrade | |
| N5446A-002 | 20 to 25 GHz bandwidth upgrade | |
| N5446A-003 | 25 to 30 GHz bandwidth upgrade | |
| N5446A-004 | 16 to 25 GHz bandwidth upgrade | |
| N5446A-005 | 16 to 30 GHz bandwidth upgrade | |
| N5446A-006 | 20 to 30 GHz bandwidth upgrade | |

Note: Purchase two or more upgrade options to go from 16 to 25 or 30 GHz and 20 to 30 GHz.

To upgrade the probe bandwidth, you simply need to send the probe to the Keysight service center.

Other recommended accessories for InfiniiMax III/III+ probing system

| Model number | Description | Notes |
|--------------|--|---|
| N2787A | 3D probe positioner | For hands-free probing |
| N5450B | Extreme temperature extension cable | 1 m long, check out Keysight literature 5990-3504EN for other available probe accessories for extreme temperature testing |
| N2812B | High performance input cable, 2.92 mm connectors, 1 m length | For use with Infiniium V, 90000-X/Q Series oscilloscope |
| N5448B | Phase matched cable pair, 25 cm, 2.92 mm (m) to 2.92 mm (m) | > 40 GHz bandwidth. Skew error matched to < 5 psec |
| N2823A | Phase matched cable pair, 1 m, 2.92 mm (m) to 2.92 mm (m) | > 40 GHz bandwidth. Skew error matched to < 5 psec |
| MV-23 | Carson Optical MagniVisor | www.carsonoptical.com/Magnifiers |



www.keysight.com/find/infiniimax3

Learn more at: www.keysight.com

For more information on Keysight Technologies' products, applications or services, please contact your local Keysight office. The complete list is available at: www.keysight.com/find/contactus



Find us at www.keysight.com

This information is subject to change without notice. © Keysight Technologies, 2015 - 2021, Published in USA, June 21, 2021, 5990-5653EN

Page 11